

# A Novel Approach Towards Advanced Driver Assist System Based on Biological Parameters

Baby K. A<sup>1</sup>, Sojan Francis<sup>2</sup>

P.G. Student, Department of Electronics and Communication Engineering, Vidya Academy of Science & Technology,

P. O. Thalakkottukara, Kerala, India<sup>1</sup>

Assistant Professor, Department of Electronics and Communication Engineering, Vidya Academy of Science &

Technology, P. O. Thalakkottukara, Kerala, India<sup>2</sup>

**ABSTRACT:** In today's scenario, the growth in the automotive sector is tremendous. As technology improves on one side, there are a large number of accidents happening on the other side. So it is essential that there is some kind of control over this unwanted growth in accidents. This paper proposes an ADAS system which is a vision based ADAS that is implemented on an embedded platform. We propose lane analysis using selective regions (LAsER), that takes advantage of the saliency of the lane features to estimate and track lanes in a road scene captured by on-board camera. The proposed technique processes selected bands in the image instead of the entire region of interest to extract sufficient lane features for efficient lane estimation. A detailed performance evaluation of the proposed approach is presented, which shows that such selective processing is sufficient to perform lane analysis with a high degree of accuracy. In-Vehicle Information Systems (IVIS) and Advanced Driver Assistance Systems (ADAS) are needed to take account of driver's states and the actual driving environment. The aim is to describe a system for automatic driver drowsiness detection based on EEG.

**KEYWORDS:** ADAS, LAsER algorithm, Lane Detection, Inverse Perspective Mapping (IPM).

## I. INTRODUCTION

In-Vehicle Information Systems (IVIS) and Advanced Driver Assistance Systems (ADAS) are needed to take account of driver's states and the actual driving environment. So far, the vision systems have been rarely adopted due to cost, lack of robustness and the large size of the equipment. Monitoring the driver's behaviour has received a lot of interest recently. However, it is not the only example in the traffic-safety field where a camera vision technique is generally applicable. Lane detection and drifting, which are also an important driving performance descriptor, is typically observed by a camera implementation thus providing an opportunity for the driver to control speed and steering movements to reduce the chance of skidding.

Lane detection is first applied on the input image, and the results lane positions are used to perform the following different functions: lane drift detection and lane change detection. In order to perform the above functions, we employ the lane estimation algorithm called LAsER (lane analysis using selective regions) that was particularly designed for embedded realization in [6],[7],[8]. Although LAsER was designed as a lane detection algorithm [9], we use it in different ways to perform the four driver assistance operations [5].

- Lane Estimation.
- Lane Drift and Change Warnings.

# International Journal of Innovative Research in Science, Engineering and Technology

(An ISO 3297: 2007 Certified Organization)

Website: [www.ijirset.com](http://www.ijirset.com)

Vol. 6, Issue 6, June 2017

The most important thing of the driving is the safety of the driving. For the safedriving, the driver should be in good condition. The most important thing of the driving is the safety of the driving. For the safedriving, the driver should be in good condition. This pattern of electric activity produced on EEG can be used for various applications like sleep detection, drowsiness detection, and sleep disorders like insomnia, studying brain activities of coma patients and to diagnose many other conditions which affect the brain [10]. The EEG signal has various frequency bands, including the delta band (0.5-4 Hz), which corresponds to sleep activity, the theta band (4-8 Hz), which is related to sleepiness, the alpha band (8-13 Hz), which represents relaxation and creativity, and the beta band (13-30 Hz), which corresponds to alertness [11]. The accelerometer can measure the static acceleration of gravity in tilt-sensing applications as well as dynamic acceleration resulting from motion, shock, or vibration. The ADXL335 is a complete 3-axis acceleration measurement system. The ADXL335 has a measurement range of 3g minimum. Ultrasonic sensors are devices that use electrical/mechanical energy transformation to measure distance from the sensor to the target object. The work in this paper is divided in two stages. 1) Lane- Detection 2) Drift Warning 3) Driver Attention 4) Distance from the front obstacles 5) Measurement of static acceleration.

Paper is organized as follows. Section II describes lane detection using LASER algorithm. The block diagram represents the entire system. In Section III lane detection and drift analysis are checked and finds whether drift has happened using IPM and provide early warning when drift has found. Section IV presents experimental results and observations showing results of images tested. Finally, Section V presents conclusion.

## II. RELATED WORK

Lanes in a road scene are used to extract the critical information about the drive in most naturalistic studies [4],[5],[7]. In [2], lane-change events were used to determine the driving characteristics leading to crashes or near crashes. In addition, the behaviour of vehicles in adjacent lanes was also considered a contributing factor to driver attentiveness in [3]. Lane-type information can be useful in determining the behaviour of such vehicles in adjacent lanes. Lane-change maneuver were studied in significant detail in the Phase- II report of the 100-car NDS to identify the contributing factors during a lane-change maneuver that lead to crashes and incidents. Identifying the lane changes of a subject vehicle and the road conditions under which such lane changes have occurred (such as the traffic density, etc.) was one of the key steps discussed in [1]. In [12], the potential of collision avoidance systems in avoiding rear-end crashes was investigated, and the vehicle localization in the lane was studied as one main semantic information to study rear-end collisions.

Lanes played a pivotal role in the evaluation of road departure crash warning systems on naturalistic driving behaviour in [6]. Similar lane-keeping studies were also presented in [7]. In [8] and [9], lane variability was one of the key metrics that was used to identify the levels of driver fatigue and drowsiness. The concern of distracted driving can be tied to the research carried by which found attention sharing generated by phone use appears to increase the drivers mental workload thereby overloading the drivers cognitive capacities and impaired the driving performance. The study carried out on cognitive distraction shows, during the cell phone conversation, drivers are observed to be looking at the sky much more often, not at the road, traffic, or road signs. It is commonly observed that, while the drivers are in-depth conversation, they simply ignore the other road users and even close their eyes as they are imbibed in their talk. This is counterproductive to driving safely. The outcome of the research carried out by [3] show, driver behaviors such as impaired gap judgment, reduced sensitivity to road conditions, poor lane maintenance, and the increase in reaction time to driving-related events can all be as a result of distracted driving. Lane analysis involves data-intensive processing of input video frames to extract lanes that form a small percentage of the entire input image data.

In this paper, we propose lane analysis using selective regions (LASER) [5], that takes advantage of the saliency of the lane features to estimate and track lanes in a road scene captured by on-board camera. The proposed technique processes selected bands in the image instead of the entire region of interest to extract sufficient lane features for efficient lane estimation. A detailed performance evaluation of the proposed approach is presented, which shows that such selective processing is sufficient to perform lane analysis with a high degree of accuracy.

# International Journal of Innovative Research in Science, Engineering and Technology

(An ISO 3297: 2007 Certified Organization)

Website: [www.ijirset.com](http://www.ijirset.com)

Vol. 6, Issue 6, June 2017

In this paper, we propose lane analysis using selective regions (LAsER) represented in Figure 1, that takes advantage of the saliency of the lane features to estimate and track lanes in a road scene captured by on-board camera. The proposed technique processes selected bands.

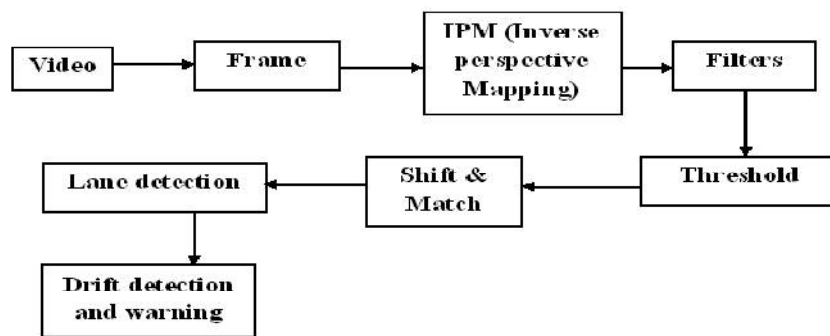

Figure 1 Block Diagram of LAsER Algorithm

Video is converted to frame for image processing section and transform the pixel coordinate to IPM coordinate for which provides a top view of the road scene. Filter is used for further smoothing and band selection and for detecting lane left and right threshold will be applied and shift matching processes applied to it and find the drift and provide warning.

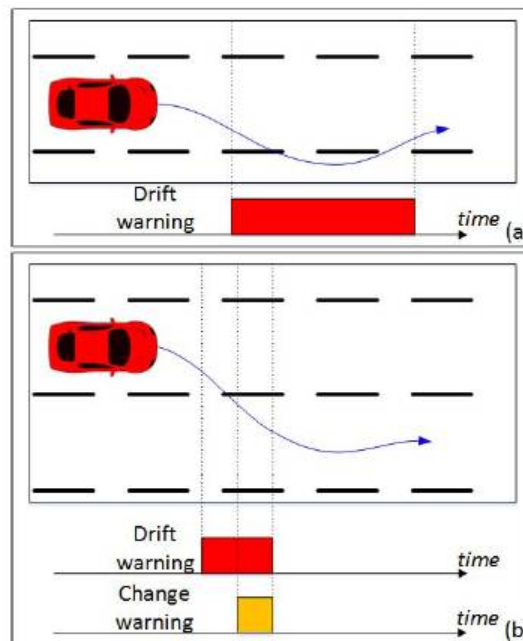

Figure 2 Lane drift and change (a) Lane drift warning (b) and lane change warning.

## International Journal of Innovative Research in Science, Engineering and Technology

(An ISO 3297: 2007 Certified Organization)

Website: [www.ijirset.com](http://www.ijirset.com)

Vol. 6, Issue 6, June 2017

In Figure 2, (a) shows lane changes of a vehicle with respect to time. The figure 2(b) represents the lane change warning. Notice that during drifting/departure in ARM processor keeps track of which lane the ego-vehicle is located.

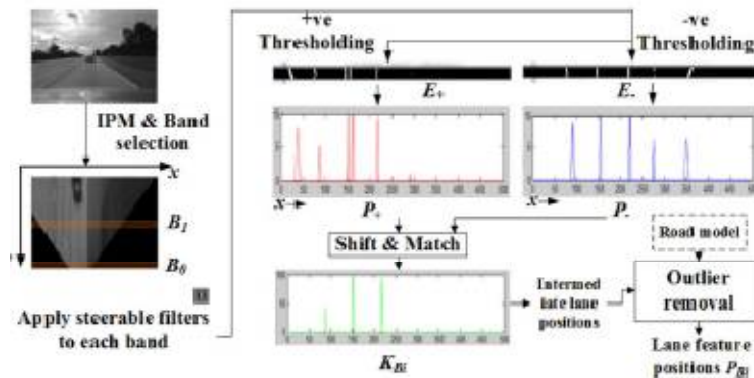

Figure 3: Block diagram illustrating lane analysis using selected regions (LAsER).

In LAsER, selected bands, not the entire region of interest, are used to detect the lane features. In Figure 3, an image I is first converted into its inverse perspective mapping (IPM) image IW, resulting in the top view of the road scene. In this IPM image, Ns scan bands (denoted by B0 and B1 in Figure. 3), each of height hB pixels, are selected along the vertically-axis, i.e., along the road from the ego vehicle. Each band Bi is then convolved with a vertical filter that is derived from steerable filters. The vertical filter is represented by the following equation:

$$G^0(x, y) = \frac{-2x}{\sigma^2} e^{x^2+y^2/\sigma^2} \quad (1)$$

Equation (1) is a 2-D Gaussian function. Therefore, filter response is given by

$$B_i^s = B_i * G^0(x, y) \quad (2)$$

Equation (2) represents the convolution operation. The significance of the 2-D Gaussian function, the implications of standard deviation, and the convolution operations are explained. From each band is then analysed for the lane features by thresholding using two thresholds to generate two binary maps E+ and E- for each band. Vertical projections p+ and p- are computed using E+ and E-, respectively, which are then used to detect the lane features using a shift-and-match operation (SMO) in the following way:

$$K = (p+ \ll \delta) \odot p \quad (3)$$

Equation (3) represents pointwise multiplication, delta is the amount of left shift that vector p undergoes. The given equation for the SMO can be explained using Fig. 2 in the following way. The peaks in p+ and p represent the dark to light and light-to-dark transitions in the band, respectively. Therefore, shifting p by delta pixels to the left and then multiplying the resulting vector with p+ will result in detecting the adjacent light-to-dark and dark-to-light transitions, which characterize the lane features.

# International Journal of Innovative Research in Science, Engineering and Technology

(An ISO 3297: 2007 Certified Organization)

Website: [www.ijirset.com](http://www.ijirset.com)

Vol. 6, Issue 6, June 2017

### III. PROPOSED METHOD

This is because the analysis presented in this paper is only a first step towards more such studies for automatically analysing naturalistic driving data that could enable a multitude of solutions for driver safety, traffic safety systems and controllers for intelligent vehicles. In this study, we characterized lane change maneuvers that are detected in naturalistic driving data based on two camera views, ego-vehicle dynamics and in-vehicle kinematics information. Semantics such as the aggressive nature of the lane change maneuvers are extracted to generate a drive quality analysis report. Additionally, considering that lane and vehicle detection are being explored for implementation on embedded processors online drive analysis using mobile computing platforms in order to provide the driver an analysis of the drive in real-time is a possible future direction.

Figure 1 shows the block diagram of the proposed system which uses a new technology which is based on an Embedded Linux board named Raspberry Pi. The images of road view are captured by using a Pi-Cam. From the images, applying the LASER algorithm, lane detection and early warning is to be done by Matlab programming. Speed of the vehicle is controlled and gives indication to other vehicles when a drift occurs. It is linked with Raspberry Pi. Distance from the front obstacles are measured by ultrasonic sensors. The obstacles' position is calculated and if it is near to the vehicle, gives an alert to the driver. The vibration or jerking of the vehicle is detected by the accelerometer. The attention of the driver is checked by electrodes. EEG signals are linked with the Raspberry Pi via a Bluetooth module. Monitoring the driver's concentration and can control the speed of the vehicle. If any condition of drowsiness, it can be alert to the driver. All the works are done parallel and make more road safety driving.

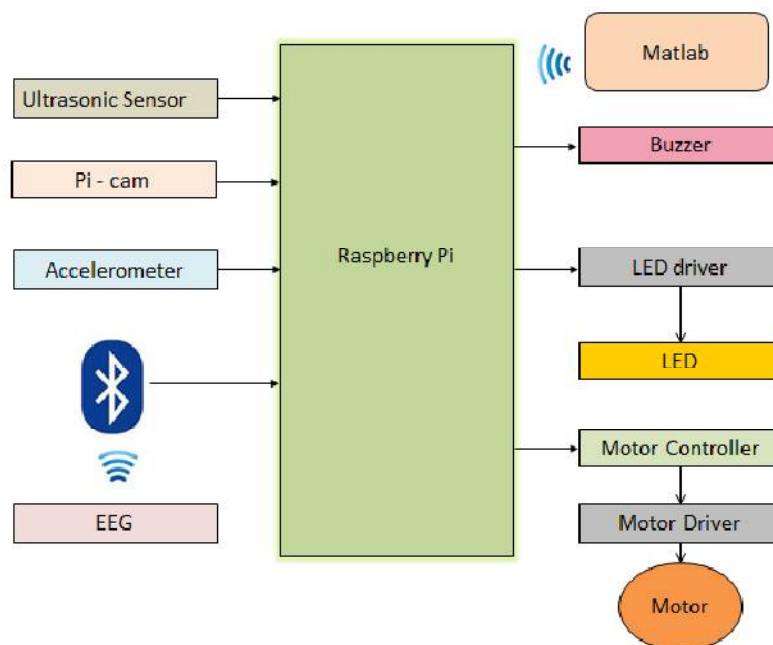

Figure 4: Proposed Block Diagram

# International Journal of Innovative Research in Science, Engineering and Technology

(An ISO 3297: 2007 Certified Organization)

Website: [www.ijirset.com](http://www.ijirset.com)

Vol. 6, Issue 6, June 2017

## IV. EXPERIMENTAL RESULTS

Figure 5 shows the entire hardware of the project designed which consist of RaspberryPi and its associated hardware components.

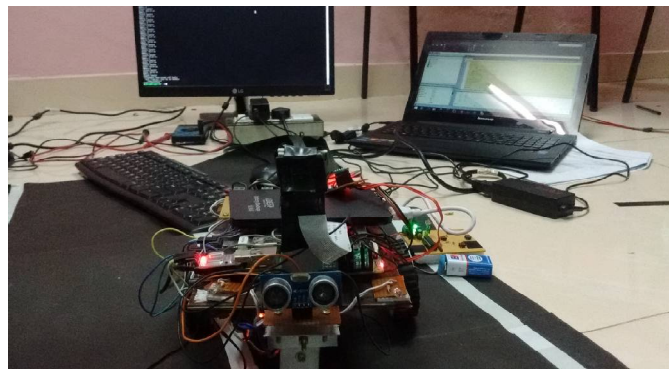

Figure 5. Entire system

Road view 1 in Figure 6 shows the camera view of the vehicle which is running forward. The real time images are continuously captured by the camera. Road view 2 in Figure 6 shows the change in the vehicle from the lane. Which indicate movement of the vehicle is from left to right and there is a chance for drifting. The gaps between scale measurement shows the chance for drifting. Road view 3 in Figure 6 shows the drift. It can be controlled by the band width value of image. When a drift occurs the speed of the vehicle is reduced and gives indication of flash lights to other vehicles.

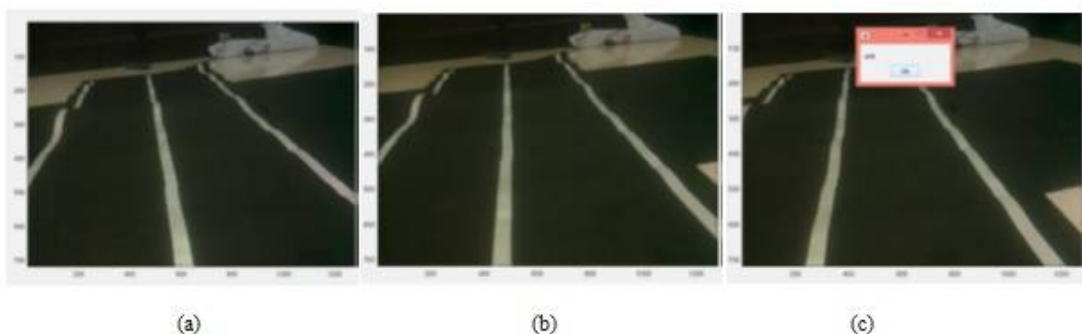

Figure 6. Road views (a) Road view 1 (b) Road view 2 (c) Road view 3

Screen shot of road strips from Raspbian OS monitor when Raspberry Pi working. Strips of the road are displayed in (a), (b), (c) corresponding to the road view 1, road view 2 and road view 3. Unlike the entire image the selected bands are used to detect lane feature. Shift and match algorithm is used to find white lines on the road. The successive frames of the road strips are comparing for finding the change in the lane position. The white content of the previous frame is checked with the current frame. If any change greater than a threshold value, which then shows the drift of the vehicle.



# International Journal of Innovative Research in Science, Engineering and Technology

(An ISO 3297: 2007 Certified Organization)

Website: [www.ijirset.com](http://www.ijirset.com)

Vol. 6, Issue 6, June 2017

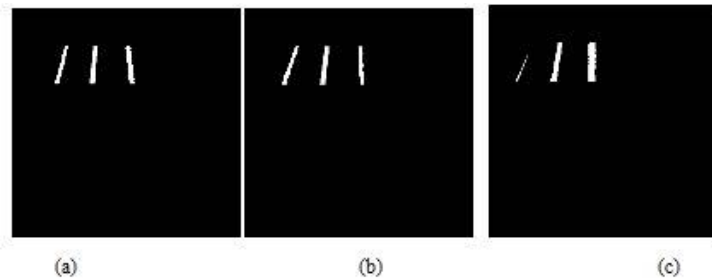

Figure. 7 Lane strips (a) Lane strips of road view 1 (b) Lane strips of road view 2 (c) Lane strips of road view 3

It is evident that reducing the number of scan bands will reduce the detection accuracy of the lane features because depending on the position of the lane marker and the speed of the vehicle, the scan band at a particular coordinate may fail to detect lanemaking. So having more scan bands increases detection rate as seen in Figure 8, bandwidth=15 and in band width of 25. Figure 8, seven bands having the accuracy of 90% this is important observation because this implies that for the IPM images of size 480x640, processing just 7 scan lines, each is sufficient to get a detection rate of 90%.

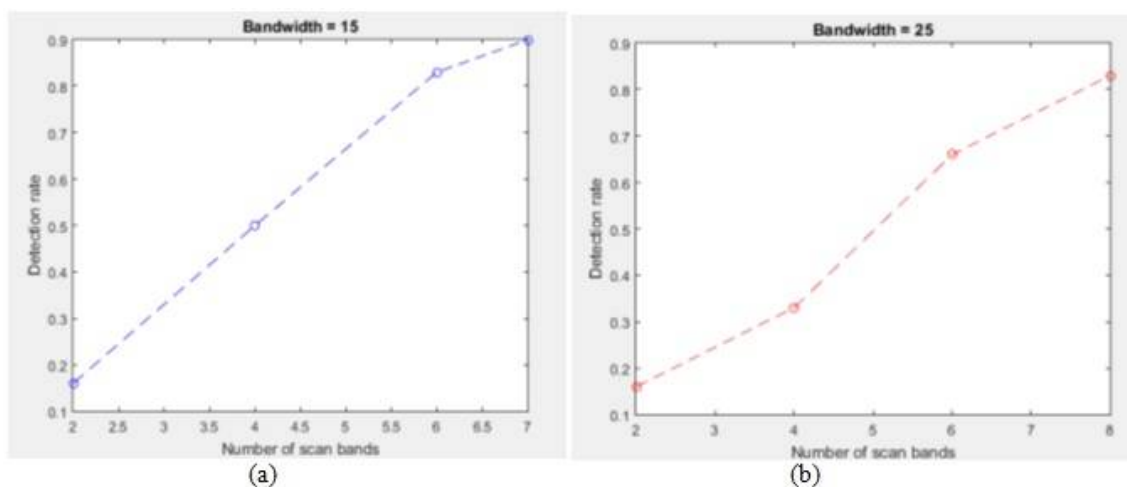

Figure 8. Detection rate versus number of scan bands (a) Bandwidth=15 (b) Bandwidth =25

The screen shot values are shown in Figure 9. Attention which indicates the intensity of a user's level of mental "attention" such as that which occurs during intense concentration and directed mental activity. Its value ranges from 0 to 100. Here we set the concentration value is above 40. The attention of the driver gets below 40, the speed of the vehicle is controlled and switch on the flash lights for indication. Makes alarm to alert the driver. The distance is obtained from ultrasonic sensor. Its range set for the obstacle is 20cm. Within the value of 20cm if there is any obstacle makes alert to the driver. Acceleration measurement is set default as one. If any vibration its value changed to zero. If the value is zero, makes alarm to driver.

# International Journal of Innovative Research in Science, Engineering and Technology

(An ISO 3297: 2007 Certified Organization)

Website: [www.ijirset.com](http://www.ijirset.com)

Vol. 6, Issue 6, June 2017

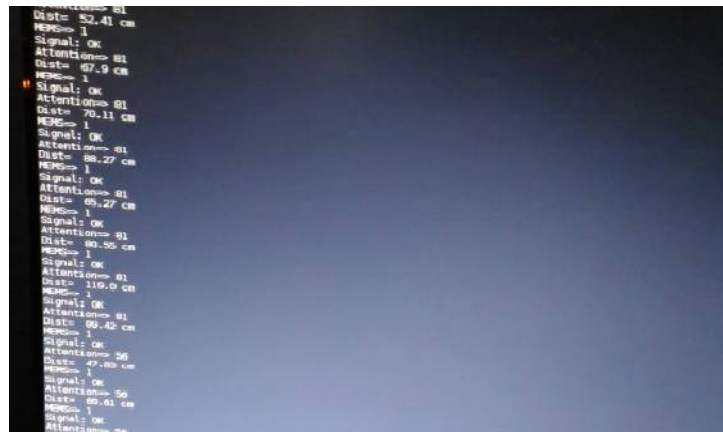

Figure 9. Screenshot values

## V. CONCLUSION

In this project, LAsER that estimates and tracks lanes by extracting salient lane features from selective scan bands. It is shown that processing narrow bands of the image gives sufficient information because of the saliency of the lane features. A detailed evaluation with ground truth information showed that LAsER gives an error of less than 8 centimetres for ego-vehicle localization on a dataset. The evaluation also showed that having 8 scan bands gives detection rates as high as 90%. As part of future work, it is envisaged to use LAsER for context-aware lane analysis. The sleep detection system implemented has a specific set of advantages over the existing method and proves to be more efficient and economical in comparison. Through research presented in this project, implement a driver drowsiness detection system which can be used in intelligent vehicles for accident prevention and making the world a much better and safe place to live.

## REFERENCES

- [1] L. N. Boyle et al., Integration of analysis methods and development of analysis plan SHRP2 safety research, Transp. Res. Board Nat. Acad., Washington, DC, USA, Tech. Rep, 2012.
- [2] V. L. Neale, T. A. Dingus, S. G. Klauer, and M. Goodman, An overview of the 100-car naturalistic study and findings, VTTI, Blacksburg, VA, USA, Tech. Rep, 2002.
- [3] Mark P. Philipsen, Morten B. Jensen, Ravi K. Satzoda, Mohan M. Trivedi, Andreas Mgelmoose and Thomas B. Moeslund, Day and Night-Time Drive Analysis using Stereo Vision for Naturalistic Driving Studies IEEE Intelligent Vehicles Symposium (IV) COEX, Seoul, Korea, 2015.
- [4] R. Satzoda and M. Trivedi, Drive analysis using vehicle dynamics and vision-based lane semantics, Intelligent Transportation Systems, IEEE Transactions on Transportation, vol. 16, no. 1, pp. 918, Feb, 2015
- [5] R. Satzoda and M. Trivedi, Selective Salient Feature based Lane Analysis, IEEE Intelligent Transportation Systems Conference, 2013.
- [6] Ravi Kumar Satzoda, Sean Lee, Frankie Lu, and Mohan M. Trivedi, Snap-DAS: A Vision-based Driver Assistance System on a Snapdragon™ Embedded Platform, IEEE Intelligent Vehicles Symposium (IV) June 28 - July 1, COEX, Seoul, Korea, 2015.
- [7] R. K. Satzoda and M. M. Trivedi, Vision-based Lane Analysis : Exploration of Issues and Approaches for Embedded Realization, IEEE Conference on Computer Vision and Pattern Recognition Workshops on Embedded Vision, 2013.
- [8] Video-Based Lane Estimation and Tracking for Driver Assistance: Survey, System, and Evaluation IEEE Transactions on Intelligent Transportation Systems, vol. 7, no. 1, pp. 2037, Mar, 2006.
- [9] M. Bertozzi and A. Broggi, GOLD: a parallel real-time stereo vision system for generic obstacle and lane detection, IEEE transactions on image processing, vol. 7, no. 1, pp. 6281, Jan, 1998.
- [10] K. Shabnal, Nibin Thomas., EEG Based Method for Detecting Driver Drowsiness and Distraction in Intelligent Vehicles, International Journal of Engineering and Technology (IJET), 2015.
- [11] San Jose CA 95113 Silicon Valley Headquarters, Neurosky, Inc., <http://www.neurosky.com/>
- [12] A. Borkar, M. Hayes, and M. T. Smith, A Novel Lane Detection System With Efficient Ground Truth Generation IEEE Transactions on Intelligent Transportation Systems, vol. 13, no. 1, pp. 365374, Mar, 2012.